

Atholl SCDC - 26 Nov 24 - Alison N's Programme

1 TAMBOURINE R32 · 3/4L

Lawrie Bowlen: East Ivanhoe Book · Crib: MiniCribS · Diagram: Keith Rose's Diagrams

- 1-8 1s lead down the middle & back to 2nd place own side (2s step up 3-4)
- 9-16 1s dance 1/2 LSh reels of 3 across, passing 1st corners LSh;
1s dance 1/2 RSh reels of 3 on opposite sides (Man up, Lady down). 1s end in 2nd place opp sides, all dancing loops into place
- 17-24 1s dance 1/2 LSh reels of 3 across (Man up Lady down);
1s dance 1/2 RSh reels of 3 on own sides (Man down, Lady up). End 2 1 3 4
- 25-32 2s+1s+3s circle 6H round & back

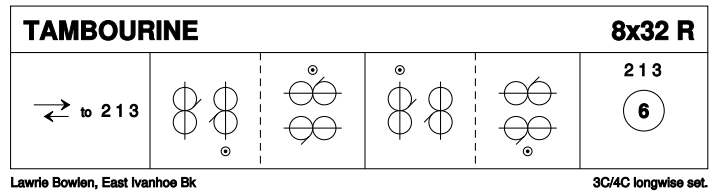

2 GEORGIE'S JIG J32 · 4/4L

Lewis N Derrick: The Leaflet Dances with Music · Crib: MiniCribS · Diagram: Keith Rose's Diagrams

- 1-8 1L+2M also 3L+4M set facing diagonally, Ladies cast 1 pl as Men cast up & dance into centre (1M & 2L also 3M & 4L step down/up 1/2 pl), top 4 dancers also bottom 4 dance RH across
- 9-16 2M+1L+4M+3L dance 1/2 reel of 4 up/down centre, top 4 dancers also bottom 4 dance RH across 1.1/4 times to bring other dancers into centre
- 17-24 1M+2L+3M+4L dance 1/2 reel of 4 in centre, top 4 dancers also bottom 4 dancers dance RH across to end with 4s+3s+2s in centre for Allemande
- 25-32 4s+3s+2s dance Allemande

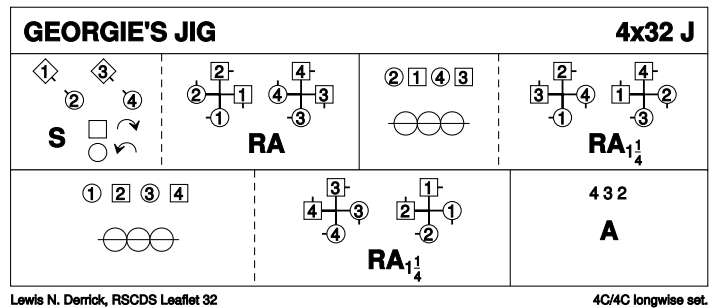

3 FROM SCOTIA'S SHORES WE'RE NOO AWA' S32 · 3/4L

Robert M Campbell: The Leaflet Dances with Music · Crib: MiniCribS · Diagram: Keith Rose's Diagrams

- 1-8 1s turn RH, cast 1 place, 3/4 turn RH, 1L dances up & casts round 2L as 1M dances down to 3rd place & casts up round 3M to 2nd place
- 9-16 1s turn 1st corners RH pass partner RSh, turn 2nd corners RH & pass partner RSh to 2nd place own sides
- 17-24 1s dance reflection reels of 3 on own sides (1s dancing out & up to start), 1s & 2s continue reel with extra loop to end 1 2 3
- 25-32 1s+2s dance Tournee :

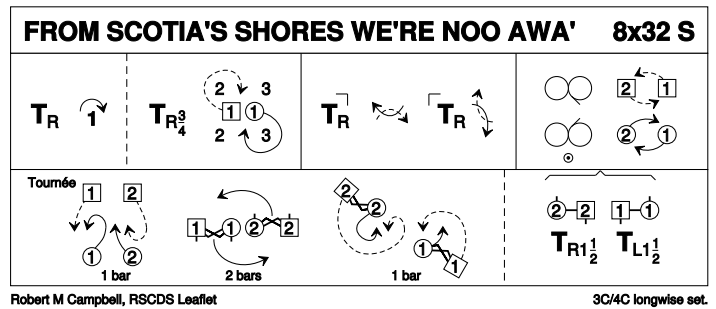

1s+2s dance into prom hold (Men with prtnr on right, 1s face M's side & 2s L's side), couples 1/2 wheel anticl'wise & Men turn Ladies into middle, both couples turn 1.1/2 times (2s RH, 1s LH) & dance out to places

4 INVERNEILL HOUSE R32 · 3/4L

John Drewry: RSCDS XXXV 2 · Crib: MiniCribS · Diagram: Keith Rose's Diagrams

- 1-8 1s+2s dance 1/2 double Fig of 8 (1s cross down), 1s dance down between 3s as 2s dance out & up then 1s cast up to 2nd place opp sides
- 9-16 1s+3s dance 1/2 double Fig of 8 (1s cross down), 1s dance up between 2s & cast to 2nd place own sides
- 17-24 1s Petronella to opposite sides
- 25-32 2s & 3s Petronella to own sides while 1s cast RSh round 1st corner & cross between 2s/3s, 1s cast to 2nd place own sides & all set

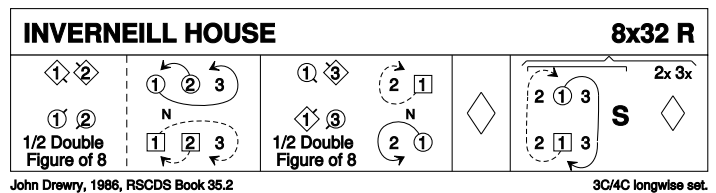

5 NILES ROBERTS' FAREWELL TO PASADENA J32 · 3/4L

Doug Macdonald: RSCDS LIII 18 · Crib: MiniCrib · Diagram: Keith Rose's Diagrams

- 1-8 1s cross RH, cast (2 step up); 1s cross down LH between 3s & cast up to face 1st corners
- 9-16 1s dance 1/2 reel of 4 with 1st corners **while** 2nd corners set twice; 1s dance 1/2 reels of 3 on opp sides (LSh to 2nd corner, 1M up, 1L down)
- 17-20 1s dance 1/2 reel of 4 with 2nd corners (in 1st corner pstns) **while** 1st corners (2M & 3L in 2nd corner pstns) set twice
- 21-24 1s dance 1/2 reels of 3 on opp sides (LSh to 2nd corner pstn, 1M up, 1L down). 1s end in centre LSh to LSh ready for...
- 25-28 1s 1/2 turn LH, dance out of ends (1M up, 1L down) **while** 3s+2s cross RH with partner & set
- 29-32 1s cast left to 2nd place own side **while** 2s+3s change places RH on sides, all set. 2 1 3

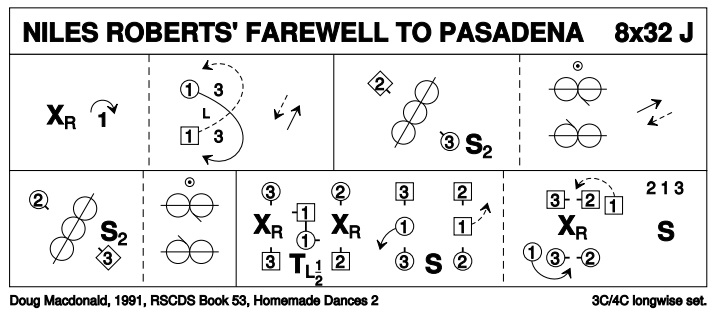

6 SCHIEHALLION M128 · 4S

Hugh A Thurston: RSCDS LIII 17 · Crib: MiniCrib · Diagram: Keith Rose's Diagrams

Strathspey

- 1-16 All dance Chorus: Grand Chain 1/2 way, set HS, Grand Chain 1/2 way & set HS & Men end BtoB in the middle facing partners
- 17-24 Men set (rocking step) as Ladies petronella turn & set, petronella turn & set to move 1/2 way round set
- 25-32 Ladies change pl RH with opp Man, Ladies dance LH across 1/2 way & turn partners RH
- 33-48 Repeat bars 1-16 (Chorus)
- 49-56 All dance RH across 1/2 way (Men on outside), all change places with prttrs advancing 1 place & change places again advancing 1 more pl
- 57-64 All repeat bars 49-56 back to places

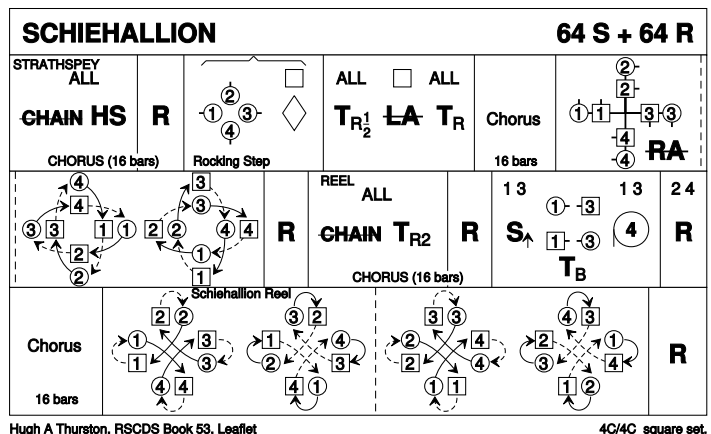

Reel

- 1-16 All dance Chorus: Grand Chain 1/2 way, turn partner with R arms twice, Grand Chain 1/2 way & turn partner R arms twice
- 17-32 1s+3s set advancing, turn opposite dancer & circle 4H round to left, 2s+4s repeat
- 33-48 Repeat bars 1-16 (Chorus)
- 49-64 All dance full Schiehallion Reel: (Men start by crossing to the right, Ladies cast & cross (following partner))
- 49-50 Men dance diagonally across set to next Ladies' position to their right **while** Ladies cast into partner's place
- 51-52 Men cast into Man's place **while** Ladies cross diagonally to Ladies' position to their right (following partner)
- 53-64 Repeat 3 more times back to original places

7 A WEE TOUCH O' CLASS J32 · 3/4L

Bill Hamilton: Scottish Dance Archives - The Donald Collection (Online List) · Crib: MiniCrib · Diagram: Keith Rose's Diagrams

- 1-8 1s+2s dance R&L
- 9-16 1M followed by 1L cast to 2nd place & cross to opp sides, 1s face down (1M facing 3L, 1L facing 3M), 1s dance RSh round 3s to end in 2nd place facing up (2s step up 11-12)
- 17-24 1s dance reels of 3 on opp sides (passing 2s LSh to start)
- 25-32 2s+1s dance LH across; 1s turn LH 1.1/2 times to end 2nd place own side

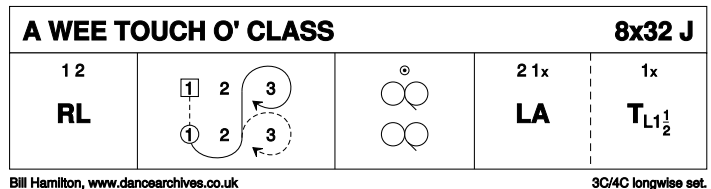

8 THE SPRING FLING REEL R40 · 3/4L

Samantha Burton: RSCDS 50 1 · Crib: MiniCrib · Diagram: Keith Rose's Diagrams

- 1-8 1s turn RH, cast (2s step up bars 3-4), cross RH, cast to Right to 1L between 2s facing down, 1M between 3s facing up
- 9-16 1L+2s & 1M+3s Adv+Ret, circle 6H 1/2 round to Left
- 17-24 1M+3s & 1L+2s Adv+Ret, 1s turn RH 1.1/4 times to face 1st corners
- 25-32 1s dance 1/2 diag reel of 4 with 1st corners, pass RSh, 1/2 diag reel of 4 with 2nd corners. 1s end in middle 1M below 1L facing own sides
- 33-40 1L+2s & 1M+3s dance LH across. 1s end 2nd place opposite sides. 2s+3s turn LH **while** 1s turn RH 1.1/2 times to own side. 2 1 3

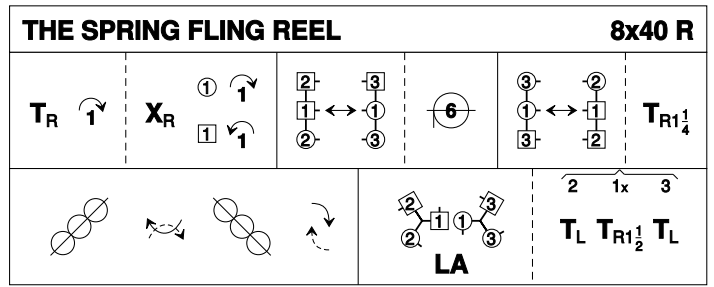

Samantha Burton, 2014, RSCDS Book 50.1

3C/4C longwise set.

9 ANDERSON'S RANT R32 · 3/4L

Miss Milligan's Miscellany of Scottish Country Dances · Crib: MiniCrib · Diagram: Keith Rose's Diagrams

- 1-8 1s cross down to dance reflection (mirror) reels of 3 on opposite sides
- 9-16 1s cross down to dance reflection (mirror) reels of 3 on own sides
- 17-24 1s lead down the middle (2s step up) & lead back up to 2nd place own sides
- 25-32 1s dance 1/2 Fig of 8 round 2s & 1/2 Fig of 8 round 3s back to 2nd place

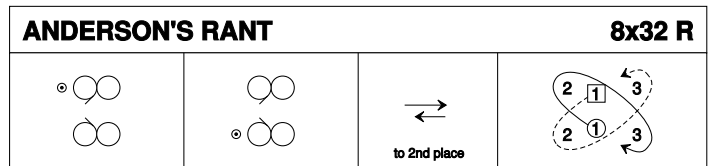

RSCDS MMM (2)

3C/4C longwise set.

10 THE WAGGLE O' THE KILT J40 · 3/4L

James B Cosh: Twenty Two SCD · Crib: MiniCrib · Diagram: Keith Rose's Diagrams

- 1-8 1s cast 1 place & lead down between 3s, cast up to 2nd place & turn LH to end BtoB facing own sides
- 9-16 1s dance RH across (1M with 2M+3M & 1L with 2L+3L), 1s passing RSh dance RH across with other side (1s end facing 1st corners)
- 17-24 1s dance 1/2 diagonal reel of 4 with 1st corners & pass LSh, 1/2 reel of 4 with 2nd corners & end facing 3rd corner (pstn)
- 25-32 1s+3rd corners 1/2 turn RH & corners turn LH 1.1/2 times in centre to face opp corner, 1s+corners 1/2 turn RH & 1s turn LH to face 4th corners
- 33-40 1s+4th corners 1/2 turn RH & corners turn LH 1.1/2 times in centre to face opp corner, 1s+corners 1/2 turn RH & 1s turn LH to 2nd place. 2 1 3

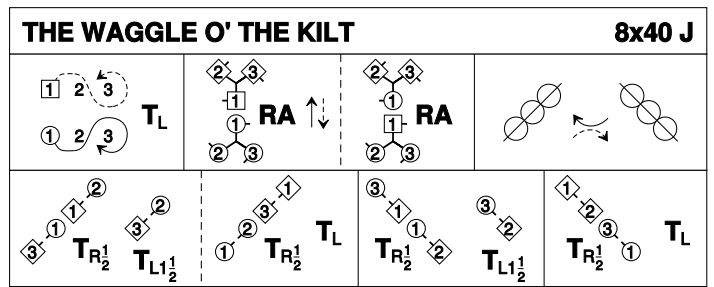

James B Cosh, Twenty Two SCD and One Other

3C/4C longwise set.

11 THE SALTIRE STRATHSPEY S32 · 4/4L

Barbara Anglin: RSCDS XLV 4 · Crib: MiniCrib · Diagram: Keith Rose's Diagrams

- 1-8 1M+2L also 3L+4M turn 2H 1.1/2 times to change places, all Men dance LH across & end facing anticlockwise giving RH to partners
- 9-16 All Set+Link with partners & Set+Link again to end on sides (1s+4s Ladies side & 2s+3s Mens side with Ladies on line ends)
- 17-24 All dance RSh reels of 4 on sides
- 25-32 1L+2M also 3M+4L turn 2H 1.1/2 times to (2)(1)(4)(3), end couples (2s & 3s) cross RH **while** centre cpls dance LH across 1/2 way & all set. 2 4 1 3

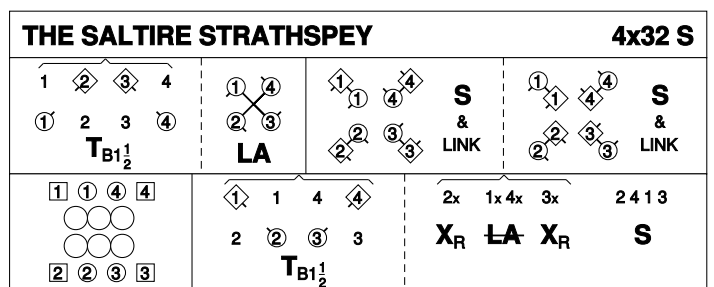

Barbara Anglin, 2001, Gatlneau Gathering, RSCDS Book 45.4

4C/4C longwise set.

12 THE KANGAROO PAW R32 · 3/4L

John Brenchley: *The Kangaroo Paw* · Crib: *MiniCribs* · Diagram: *Keith Rose's Diagrams*

- 1-8 1s set advancing & dance down the middle, Lady dances under Man's left arm to change pls & 1s dance up to end BtoB in 2nd pl facing opp sides
- 9-16 1s dance Double Triangles & end facing 2nd corner
- 17-24 1s turn 2nd corner RH, turn partner LH, turn 1st corner RH & partner LH to face out 2nd place own side
- 25-32 1s dance reels of 3 on own sides (LSh to 4th corner to start)

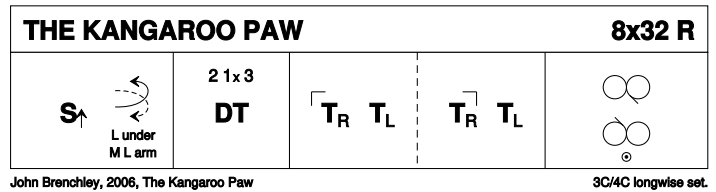

13 JOHN CASS J32 · 5/5L

Peter Avery: *RSCDS XLIX 10* · Crib: *MiniCribs* · Diagram: *Keith Rose's Diagrams*

- 1-8 1s lead down (2s+3s step up 3-4), lead up to 3rd place & turn RH to face 3M with 1L following 1M
- 9-16 1s, 3M+2M, 4L+5L all in tandem, dance alternating tandem reel on diagonal (1s pass 3M+2M RSh). 1s end facing 4M, 1L following 1M
- 17-24 1s, 4M+5M, 2L+3L all in tandem, repeat 9-16 (1s pass 4M+5M LSh) 1s end in middle, 3rd place facing down NHJ (1L on Left of 1M)
- 25-32 1s dance down between 4s, cast behind 5s (4s+5s step up 27-28), 1s pivot turn (R elbow grip) & finish in 5th place 2 3 4 5 1

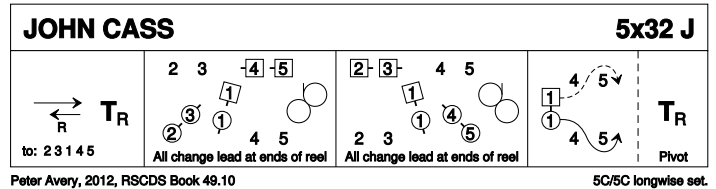

14 THE GARDENERS' FANTASIA S32 · 3/3L

Pamela Cook: *RSCDS XLVI 2* · Crib: *MiniCribs* · Diagram: *Keith Rose's Diagrams*

- 1-8 1s+2s circle 4H round to left, 1s face 2s set & 1s turn inwards cast 1 place to face 3s
- 9-16 1s+3s dance the Rondel, 1s end in 3rd place & 3s end facing 1st corners. 2 (3) 1
- 17-24 3s set to & turn 1st corners; set to & turn 2nd corners. 3s end in 2nd place opposite sides
- 25-32 2s+1s dance R&L (begin on sides) while 3s dance up between 2s & cast to 2nd pl, lead down LH b'tw'n 3rd pl, cross & cast up to 2nd pl. 2 3 1

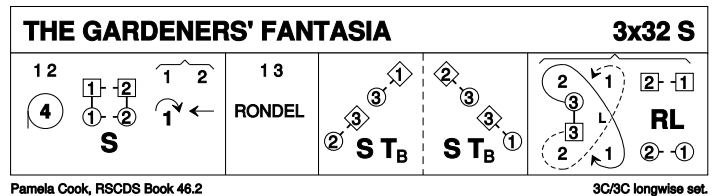

15 THE FIREWORKS REEL R32 · 3/4L

Anselm Lingnau: *RSCDS XLVIII 11* · Crib: *MiniCribs* · Diagram: *Keith Rose's Diagrams*

- 1-8 1s cross RH & cast 1 place, 1s dance 1/2 figures of 8 (1L round 2s, 1M round 3s) & end facing 1st corners
- 9-12 1s set moving out between corners (as in Hello-Goodbye setting) & 1s turn LH to face 1st corners
- 13-16 1s dance 1/2 diagonal reel of 4 with 1st corners & end facing 2nd corners
- 17-24 1s repeat bars 9-16 with 2nd corners & end 2nd place opposite sides (3)(1)(2)
- 25-32 1s dance 1/2 reel of 3 on opposite sides (1M in & down, 1L in & up), 1s dance 1/2 reel of 3 across (1M with 2s & 1L with 3s)

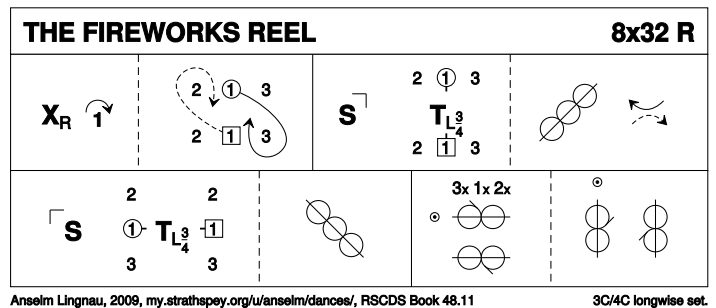

16 TODLEN HAME J32 · 3/4L

Thomas (19C) Wilson: *RSCDS XVI 6* · Crib: *MiniCribs* · Diagram: *Keith Rose's Diagrams*

- 1-8 1s+2s dance a reel of 4 across the dance (1L & 2M pass LSh, 1M & 2L dance to their Left to start). 1s end in 2nd place. 2 1 3
- 9-16 2s+1s+3s dance Grand Chain
- 17-24 2s+1s dance R&L
- 25-32 1s dance down below 3s, cast up on own sides, dance up between 2s & cast to 2nd places on own sides. 2 1 3

