

Atholl SCDC - 12 Nov 24 - Joy's Programme

1 HEDWIG'S REEL R32 · 3/4L

Stella Phillips: A Second Book of Graded Scottish Country Dances · Crib: MiniCribs · Diagram: Keith Rose's Diagrams

- 1-8 1s dance Figs of 8 on own sides (RSh to 2s)
- 9-16 1s turn RH & cast 1 place, 1s turn LH into 2nd place facing down
- 17-24 2s+1s+3s dance Grand Chain
- 25-32 2s+1s+3s Adv+Ret, 2s+1s+3s turn RH

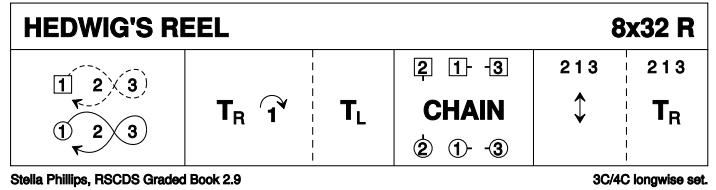

2 THE SNAKE PASS J32 · 3/4L

Norman Churnside: Life Begins at Forty · Crib: MiniCribs · Diagram: Keith Rose's Diagrams

- 1-8 1s+2s dance 1/2 R&L; 1s+3s dance 1/2 R&L
- 9-16 1s cross RH, cast up to 2nd place & dance 1/2 Figs of 8 round 3s to end facing 1st corner positions
- 17-24 1s dance 1/2 diag reel with 1st corners, pass LSh & dance 1/2 diag reel with 2nd corners ending with quick LH turn, 1L facing 3s at top, 1M facing 2s in 3rd place
- 25-32 1s dance the Snake Pass:

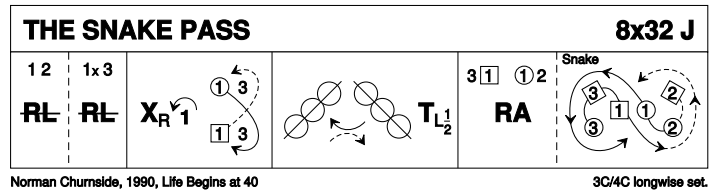

1s dance RH across (1L with 3s & 1M with 2s), 1L followed by 3s also 1M followed by 2s pass LSh diagonally across through 2nd place to change ends & loop round to left to end in 2nd place. 2 1 3

3 THE WATER OF LEITH S32 · 4/4L

John Wilkinson: RSCDS LIII 2 · Crib: MiniCribs · Diagram: Keith Rose's Diagrams

- 1-8 1s+3s set. 1L dances down, casts up round 2M into middle facing down as 1M dances across, casts round 2L into middle facing up while 3s dance same round 4s. 1s+3s change places RH with partner into line of 4 in middle (M face down, L face up)
- 9-16 1s+3s dance reel of 4 in middle
- 17-20 1s+2s also 3s+4s dance RH across
- 21-24 1M followed by 1L casts round 2L to 2nd place own sides as 3M followed by 3L casts round 4L to 4th place (2s+4s step up 23-24)
- 25-32 1s+4s (middle couples) dance Espagnole

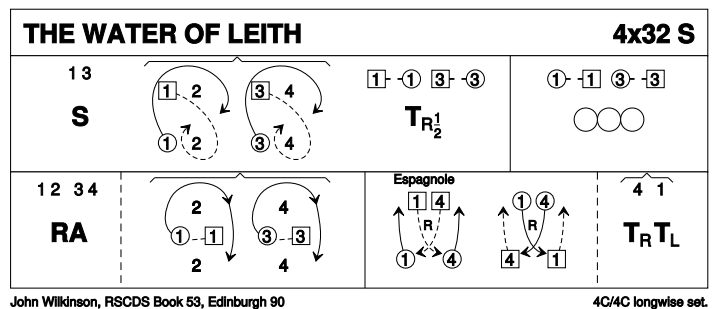

- 25-26 1s+4s cross (Ladies lead across RH passing between Men) with Ladies changing places RH
- 27-28 1s+4s cross back (Men lead across RH between Ladies) with Men changing places RH
- 29-32 4s turn RH as 1s turn LH

4 THE DANCING MAN R32 · 3/4L

Roy Goldring: A Second Book of Graded Scottish Country Dances · Crib: MiniCribs · Diagram: Keith Rose's Diagrams

- 1-8 1s & 2s turn RH once round & dance RH across once round
- 9-16 1s+2s+3s dance RSh reels of 3 on own sides, 1s & 2s continue reels & loop round at top to 2M facing 1M & 2L facing 1L (1M+2L BtoB in middle)
- 17-24 1s+2s dance 3/4 reel of 4 across (2M & 1L pass LSh end bar 22) then pass partners RSh to progressed places own sides (2 1 3)
- 25-32 2s+1s+3s circle 6H round & back

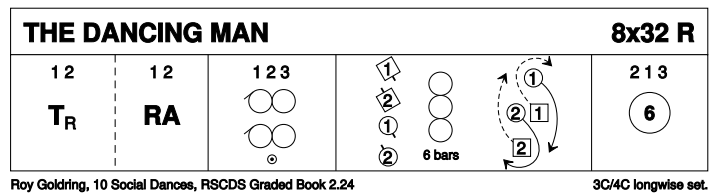

5 INCHMICKERY J32 · 5/5L

Roy Goldring: RSCDS LIII 23 · Crib: MiniCribs · Diagram: Keith Rose's Diagrams

- 1-8 1s+2s circle 4H round to left, 1s dance in & cast to 3rd place
- 9-16 1s dance RH across (1L with 3s & 1M with 4s), pass RSh & dance LH across with other couple 2 3 1 4 5
- 17-24 1L+2M (at top) also 1M+5L (at bottom) turn RH, 1s pass RSh & 1L+5M (at bottom) also 1M+2L (at top) turn LH (1s end 3rd place own side)
- 25-32 1s dance in & cast to 5th place, 5s+1s circle 4H round to right. 2 3 4 5 1

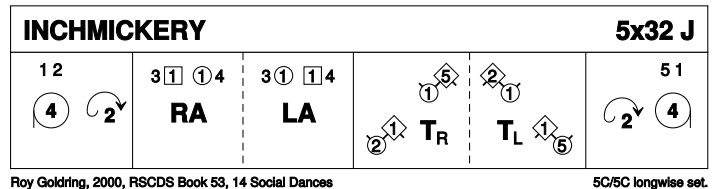

6 CULLA BAY S32 · 4S

Ann Dix: RSCDS XLI 2 · Crib: MiniCribs · Diagram: Keith Rose's Diagrams

- 1-4 1s & 3s advance & 1/2 turn opposite partner RH & cast out to opposite side
- 5-8 1s & 3s chase 1/4 round set cl'wise & dance in passing 2s/4s RSh curving in to face 2s/4s as 2s & 4s repeat bars 1-4 & turn right about to face 1s/3s
- 9-16 All dance parallel reels of 4 across set
- 17-24 2s+1s also 4s+3s circle 4H once round to left, set & dance RH across 1/2 way
- 25-32 2s+4s dance LH across once round, 2s & 4s dance out through sides passing opp partner RSh & chase round set cl'wise to next place

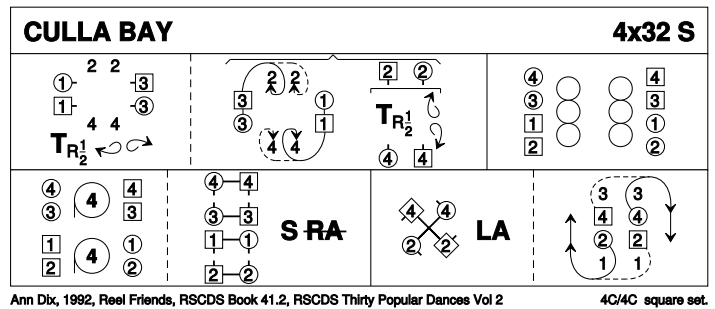

7 PULLING BRACKEN R32 · 3/4L

Anthony Bulteel: Scottish Dance Archives · Crib: MiniCribs · Diagram: Keith Rose's Diagrams

- 1-8 1s in prom hold (Lady on Man's Left) dance reel of 3 across with 2s, passing 2L LSh to start. 1s end in 2nd place own sides, 2s dance up to 1st place
- 9-16 2s+1s+3s dance Grand Chain (2s crossing at top)
- 17-24 1s cross RH to face 1st corner & turn 1st corners LH, turn 2nd corners RH & 1/2 turn partner LH ready for ...
- 25-32 1L+2s and 1M+3s dance RH across, 1s pass RSh to dance LH across with other couple & 1s end in 2nd place own sides

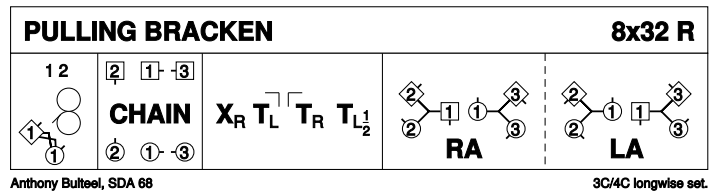

8 THE COCKET HAT J40 · 3/4L

Ken Jones: RSCDS XLIV 5 · Crib: MiniCribs · Diagram: Keith Rose's Diagrams

- 1-8 1s set & cast 1 place, dance down between 3s & cast up to 2nd place own sides
- 9-16 1s dance 1/2 reels of 3 across (Lady with 2s & Man with 3s) into 1/2 reel of 3 on opposite sides (3)(1)(2)
- 17-24 1s dance RH across (1M with 3s at top & 1L with 2s) & end facing 3rd crnr (pstn), 1s dance 1/2 diag RSh reel of 4 & pass RSh to face 4th crnr (pstn)
- 25-32 1s dance 1/2 diag reel with 4th corners & end in 2nd place own side, 1s dance RH across (1L with 2s at top & 1M with 3s)
- 33-40 2s+1s+3s circle 6H round to left for 6 steps, pivot & chase back to places

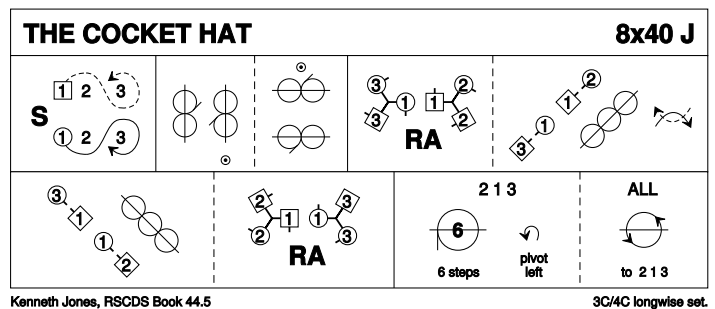

9 ORPINGTON CALEDONIANS R32 · 3/4L

John Brenchley: RSCDS XLIX 2 · Crib: MiniCribs · Diagram: Keith Rose's Diagrams

- 1-8 1s set, 1L casts & followed by 1M, dances across to 2M's place facing out (2s step up 5-6). 1L+3M also 1M+3L 1/2 turn LH & Men face out
- 9-16 3s+1s dance Ladies' Chain, 1M finishes facing out
- 17-24 1M followed by 1L casts up, dances across to 2M place (3s step down 19-20). 2s+1s dance RH across. 1M & 2L face out
- 25-32 2s+1s+3s dance reels of 3 on sides (1s+3s pass LSh to start)

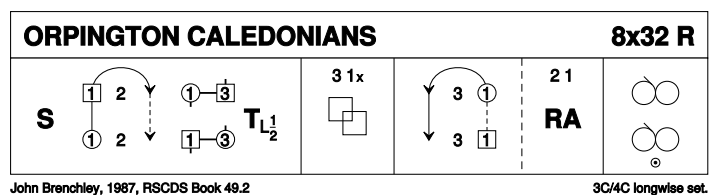

10 LINKS WITH ST PETERSBURG J32 · 3/4L

Malcolm Brown: RSCDS XLVI 10 · Crib: MiniCribs · Diagram: Keith Rose's Diagrams

- 1-8 1s & 2s Set+Link ending 2s facing 1s NHJ, 2s & 1s Set+Link with partners to opposite sides. (2)(1)3
- 9-16 1s followed by 2s dance down for 3 bars & change places with Lady dancing under Mans arm, 2s+1s dance up to 1st & 2nd places
- 17-24 2M+1M turn LH as 2L+1L turn RH, 1M+3M turn RH as 1L+3L turn LH & 1s end facing 1st corners
- 25-32 1s dance 'Hello-Goodbye' setting & petronella turn to 2nd place own sides

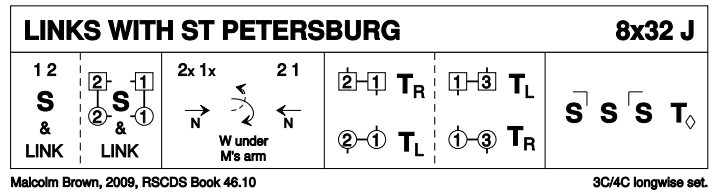

11 LADY PEAK'S STRATHSPEY S32 · 3/4L

John Drewry: The Greenburn Book 2 · Crib: MiniCribs · Diagram: Keith Rose's Diagrams

- 1-8 1s+2s set, 2s cast up **while** 1s dance down, 1s dance out behind 3s & lead up to 2nd place facing up
- 9-16 1s (prom hold) dance 1/2 diag reel of 3 with 2nd crnrs (RSh to 2L), 1s pivot inward to face out Ladies side & dance 1/2 reel with 1st crnrs (RSh to 3L)
- 17-24 Pivoting inwards repeat with next corner (RSh to 3M place) & repeat with 4th corner RSh to 2M place
- 25-32 2s+3s set & cross RH twice **while** 1s lead down below 3s, cross & cast up round 3s, lead up between 2s, cross & cast to 2nd place

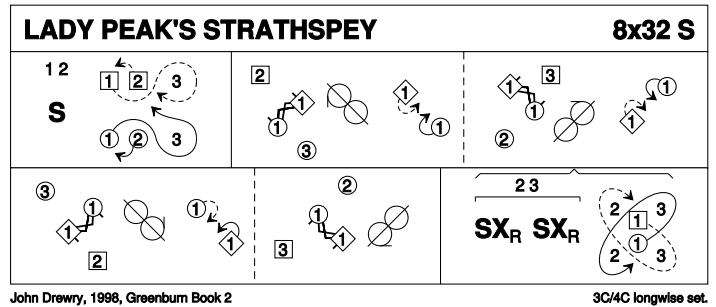

12 FAREWELL TO BALFOUR ROAD J32 · 5/5L

Andrew Buxton: RSCDS LII 7 · Crib: MiniCribs · Diagram: Keith Rose's Diagrams

- 1-8 1s+2s circle 4H round & back
- 9-16 1s+2s Set+Link; 1s+3s Set+Link
- 17-24 2s **start while** 1s+4s+5s dance mirror reels of 3 on sides (1s in/down, 5s in/up to start)
- 25-32 1s set, cross down RH to 4th place (4s step up); 1s set, cross down LH to 5th place (5s step up)

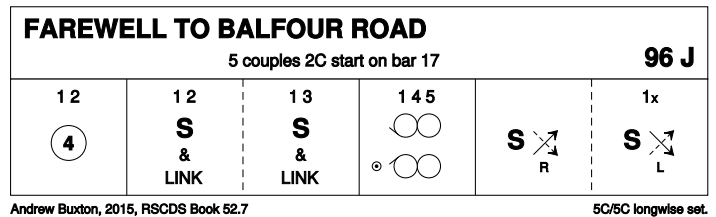

New top couple start every 16 bars. Repeat until 1s back in 1st place, they stand for 16 bars while 5s continue bars 17-32 ending back in 5th place

13 BURNIEBOOZLE R32 · 3/4L

David G Queen: Southport Book Volume 1 · Crib: MiniCribs · Diagram: Keith Rose's Diagrams

- 1-8 1s set & cast 1 place, turn partner LH 1.1/2 times to opposite sides (M facing up L down)
- 9-16 2s+1s+3s dance reel of 3 on sides giving LSh to 2nd corner & ending with 1s turning RH to face 1st corners
- 17-28 Dance to Corners & Set: (12 bars)

Couple in middle change places with corners passing RSh, corners pass RSh in middle with a 1/4 turn to right to face next corner **while** supporting corners set (2 bars). Repeat 5 more times to end with corners in diagonally opposite place and 1s meet again in middle
- 29-32 1s turn RH 1.1/2 times to 2nd place own sides **while** 2s & 3s change places RH on the sides & cross over LH

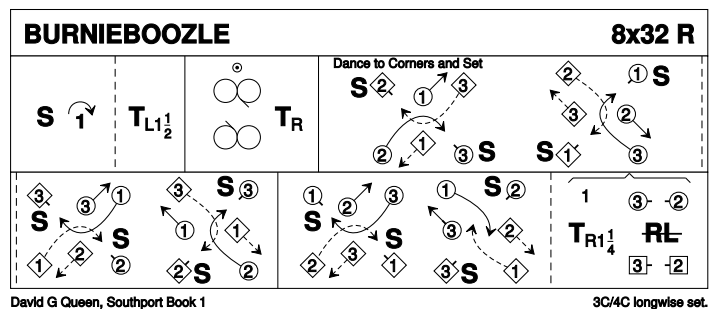

14 THE LAMMERMUIR HILLS S32 · 2/4L
Roy Goldring: Auld Friends Meet · Crib: MiniCribs · Diagram: Keith Rose's Diagrams

- 1-8 1s+2s dance Diamond Poussette
- 9-16 1L+2M cross RH & cast behind partners back to original places, 1s+2s dance RH across
- 17-24 1M+2L cross LH & cast behind partners back to original places, 1s+2s dance LH across
- 25-32 1s+2s dance the Knot

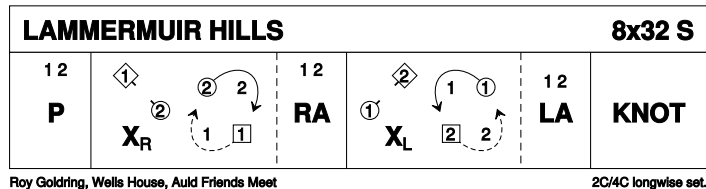

15 KNOTWORK J40 · 3/4L
Wouter Joubert: RSCDS XLIV 2 · Crib: MiniCribs · Diagram: Keith Rose's Diagrams

- 1-8 1M+2M Set+Link while 1L+2L reverse Set+Link (1s end facing out), 1s+3s set & 1/2 turn on sides (Men LH & Ladies RH)
- 9-16 2s+3s+1s dance reflection reels on own sides (1s dance up between 3s who dance out & down to start)
- 17-24 1s set, cross RH, cast up to 2nd place & turn LH to face 1st corners
- 25-32 1s dance 1/2 diagonal reel of 4 with 1st corners, pass RSh & dance 1/2 reel with 2nd corners ending in 2nd place opposite sides
- 33-40 3s+1s+2s turn partners RH & chase clockwise 1/2 way to own sides

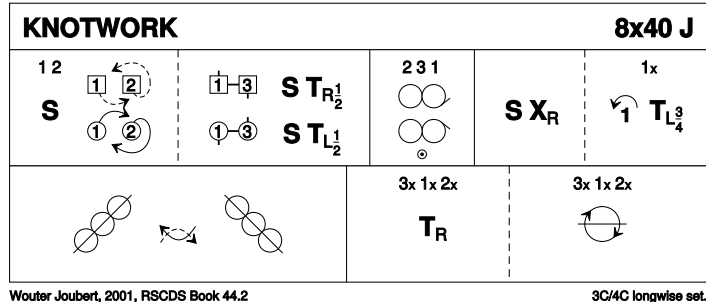

16 THE FINAL REEL R32 · 3/4L
Ian Barbour · Crib: MiniCribs · Diagram: Keith Rose's Diagrams

- 1-8 1s cross RH, cast 1 place & turn LH 1.1/4 times to end 1M between 2s & 1L between 3s
- 9-16 2s+1s+3s Set+Link for 3 twice. 1s end facing 1st corners pstns
- 17-24 1s dance 1/2 reel of 4 with 1st corners (pstn) & 1/2 reel with 2nd corners (pstn), 1s cross to 2nd place own sides
- 25-32 2s+1s+3s circle 6H round & back

