

Atholl SCDS - 5th March 2024 - Bill's Programme

1 THE RAVEN'S DANCE J32 · 3/4L

Derek Haynes: Carnforth Collection of SC Dances 5 · Crib: MiniCribbs · Diagram: Keith Rose's Diagrams

- 1-8 1s+2s dance double Fig of 8 (1s cross down & 2s dance up to start - no cast)
- 9-16 1s cross down to dance reflection reels of 3 on opposite sides & end in centre at top facing down (Lady on Man's right), 2s facing out
- 17-24 1s (Lady leading) dance an Alternating Tandem RSh reel of 3 across with 2s (RSh to 2M) & end in centre facing down, 2s in 1st place own side
- 25-32 1s dance down between 3s, cast up to 2nd place (opp sides), lead up between 2s, cross & cast to 2nd place own sides

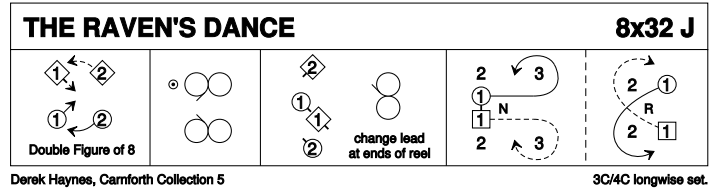

2 THE SAILOR R32 · 3/4L

RSCDS XXIV 4 · Crib: MiniCribbs · Diagram: Keith Rose's Diagrams

- 1-8 1s cross down RH to face out between 2s & 3s giving hands to each corner & set, 1s cast round 1st corner to form lines of 3 across with 2s/3s & 2s+1s+3s set
- 9-16 1s (turning to right) dance RSh reels of 3 across & 1s end passing LSh to 2nd place on opposite sides
- 17-24 1s lead down for 2 bars & lead up, cross at the top & cast to 2nd place on own sides
- 25-32 2s+1s dance R&L

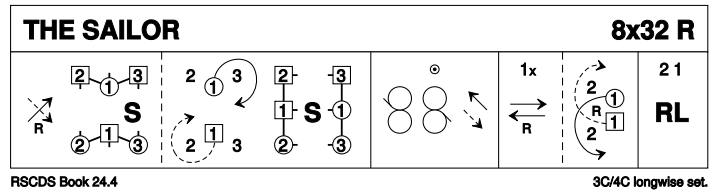

3 THE GENTLEMAN S32 · 3/4L

Roz Scott Huxley: RSCDS XXXV 5 · Crib: MiniCribbs · Diagram: Keith Rose's Diagrams

- 1-8 1s turn 2H & remain in middle facing each other as 2s step up, 1s+2s set (1s advancing & pass LSh to face opposite partner) & dance 1/2 reel of 4 across with 2s with 1s ending reel giving LH to face down on own side between 2s
- 9-16 1s dance down to end between 3s & face each other, 1s+3s set (1s advancing & pass LSh to face opposite partner) & 1/2 reel of 4 across with 3s 1s end giving LH to face up on own side between 3s
- 17-24 1s lead up to top, cross over & cast to 2nd place & 1/2 reels of 3 across (L with 2s & M with 3s)
- 25-32 2s+1s dance Diamond Poussette

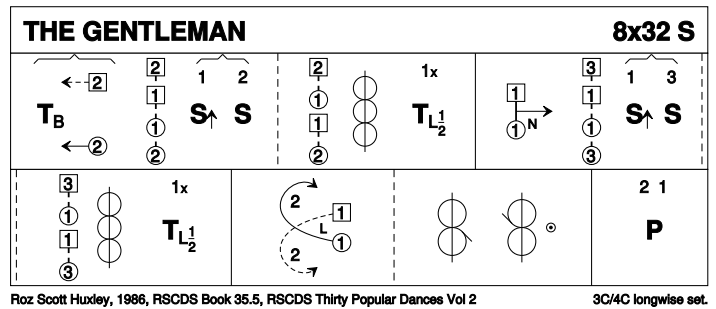

4 CHASED LOVERS J32 · 3/4L

Tim Wilson: RSCDS LIII 9 · Crib: MiniCribbs · Diagram: Keith Rose's Diagrams

- 1-4 1s set, cross down (no hands) to 2nd place facing out (2s step up 3-4)
- 5-8 1s cast down behind 3s, meet & dance up centre with 1L leading, 1M following, to face 2M (her 1st corner)
- 9-16 1s, in tandem, dance LSh reel of 3 on 1st corner diagonal (out of top of set to start), finishing by 1s pulling back RSh to face down, 1M leading, facing 3M
- 17-24 1s, in tandem, dance RSh reel of 3 on 2nd corner diagonal (out bottom of set to start), finishing with 1s facing own 1st corners
- 25-32 1s dance Pass+Turn with 1st corners, (pass RSh), Pass+Turn with 2nd corners, finishing passing RSh to 2nd place own sides

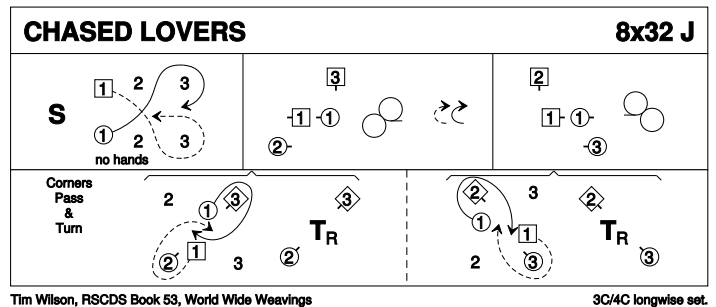

5 ANNIVERSARY REEL R32 · 4/4L

Sheila Muir: RSCDS XXXVI 7 · Crib: MiniCribs · Diagram: Keith Rose's Diagrams

- 1-8 1s cross RH & cast 1 place, 1s dance 1/2 Fig of 8 round 2s
- 9-16 1L dances full reel of 3 with 2s **while** 1M dances 1/2 reel with 3s & 1/2 reel with 4s
- 17-24 1s dance LH across with 3s, 1s dance RH across (1L with 2s & 1M with 4s)
- 25-32 1s pass LSh to dance 1/2 reel of 4 with 3s, turn RH to opposite sides **while** 4s set advancing & 1s+4s dance RH across 1/2 way round to new places

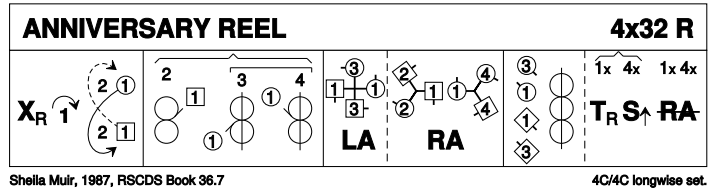

6 BROADWAY S32 · 3/3L

Chris Ronald: The Big Apple Collection · Crib: MiniCribs · Diagram: Keith Rose's Diagrams

- 1-8 1s dance down (2 bars) & turn 2H (2 bars), 1s dance up & cast to 2nd place
- 9-16 2s+1s+3s Set+Link for 3, 1s dance 1/2 Diag R&L starting Diagonally left
- 17-24 All Set+Link for 3, 1s dance 1/2 Diag R&L starting Diagonally left. (3)(1)(2)
- 25-32 All set & 1/2 turn RH, face partner and pull back RSh, dance out to places & set. 3 1 2

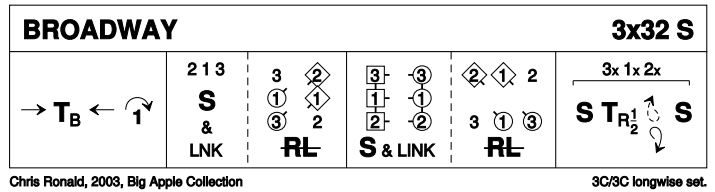

7 WE'VE NAE ELECTRIC R32 · 5/5L

Gary Coull: Jubilee Book 1929-2004 [Banffshire] · Crib: MiniCribs · Diagram: Keith Rose's Diagrams

- 1-8 1s+3s cross down RH into double triangle position & set, dance round 1st corner into a line up/down middle facing partner
- 9-16 1s+3s dance RSh reel of 4 in centre **while** 2s+4s+5s dance LSh reels of 3 on sides (4M in & up, 4L in & down to start)
- 17-24 1s & 3s 1/2 turn partner RH, dance RSh round 2nd corner & turn partner RH 1.1/2 times to 2nd/4th place own sides
- 25-32 2s (at top) stand **while** 1s+4s also 3s+5s Set+Link; All turn RH to end 2 4 1 5 3

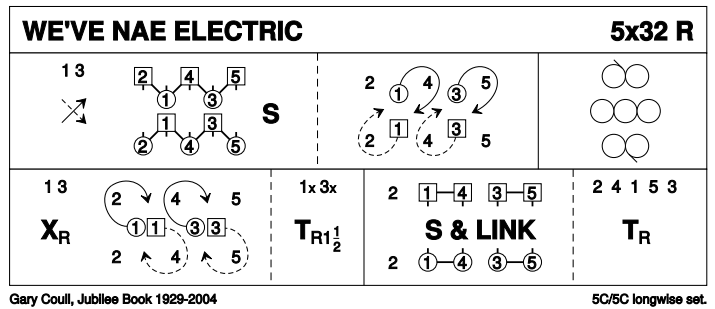

8 GOTHENBURG'S WELCOME J32 · 3/4L

Bobby Munro: RSCDS XXXVII 3 · Crib: MiniCribs · Diagram: Keith Rose's Diagrams

- 1-4 1s cast 1 place & set advancing to 1st corner
- 5-16 Dance to Corners & Set: (12 bars)
Couple in middle change places with corners passing RSh, corners pass RSh in middle with a 1/4 turn to right to face next corner **while** supporting corners set (2 bars). Repeat 5 more times to end with corners in diagonally opposite place and 1s in the middle facing 3rd corner positions
- 17-24 1s dance 1/2 diagonal Reel of 4 with 3rd corner, pass RSh & dance 1/2 diagonal Reel with 4th corners
- 25-32 1s dance RH hands across (L with 2s & M with 3s) & 2s+1s+3s turn RH

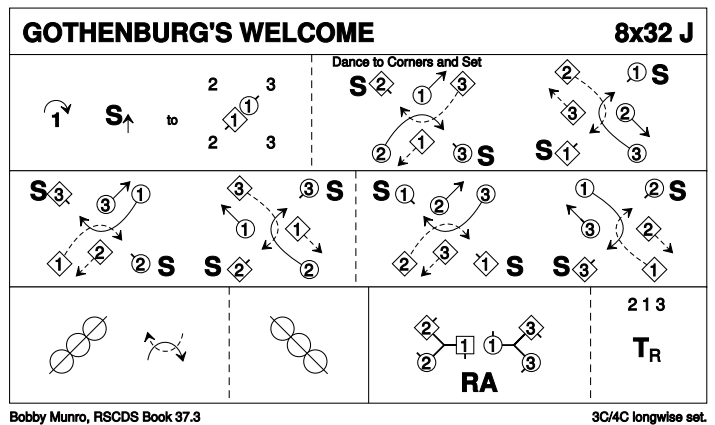

9 A WEE TOUCH O' CLASS J32 · 3/4L

Bill Hamilton: Scottish Dance Archives - The Donald Collection (Online List) · Crib: MiniCribbs · Diagram: Keith Rose's Diagrams

- 1-8 1s+2s dance R&L
- 9-16 1M followed by 1L cast to 2nd place & cross to opp sides, 1s face down (1M facing 3L, 1L facing 3M), 1s dance RSh round 3s to end in 2nd place facing up (2s step up 11-12)
- 17-24 1s dance reels of 3 on opp sides (passing 2s LSh to start)
- 25-32 2s+1s dance LH across; 1s turn LH 1.1/2 times to end 2nd place own side

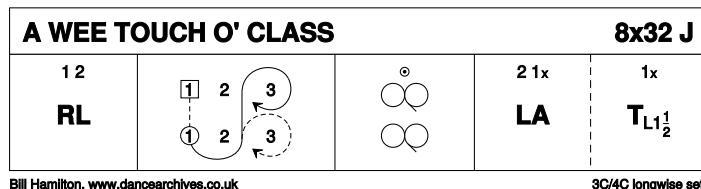

10 CADGERS IN THE CANONGATE R48 · 3/4L

Walsh (18C): RSCDS IX 10 · Crib: MiniCribbs · Diagram: Keith Rose's Diagrams

- 1-8 1s dance reels of 3 on opposite sides (1M crosses to give RSh to 2L & 1L crosses down giving LSh to 3M)
- 9-16 1s dance reels of 3 on own sides (1L crosses to give RSh to 2L & 1M crosses down giving LSh to 3M)
- 17-24 1s set to 2L, set facing down, set to 2M & back to places
- 25-32 1s+2s set & dance RH across 1/2 way, set & dance LH back to places
- 33-40 1s cross RH, cast 1 place & turn LH 1.1/2 times to own sides
- 41-48 2s+1s dance R&L

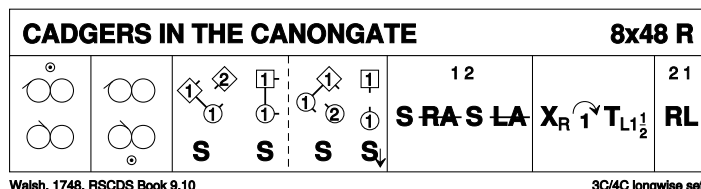

11 THE WATER OF LEITH S32 · 4/4L

John Wilkinson: RSCDS LIII 2 · Crib: MiniCribbs · Diagram: Keith Rose's Diagrams

- 1-8 1s+3s set. 1L dances down, casts up round 2M into middle facing down as 1M dances across, casts round 2L into middle facing up **while** 3s dance same round 4s. 1s+3s change places RH with partner into line of 4 in middle (M face down, L face up)
- 9-16 1s+3s dance reel of 4 in middle
- 17-20 1s+2s also 3s+4s dance RH across
- 21-24 1M followed by 1L casts round 2L to 2nd place own sides as 3M followed by 3L casts round 4L to 4th place (2s+4s step up 23-24)
- 25-32 1s+4s (middle couples) dance Espagnole
- 25-26 1s+4s cross (Ladies lead across RH passing between Men) with Ladies changing places RH
- 27-28 1s+4s cross back (Men lead across RH between Ladies) with Men changing places RH
- 29-32 4s turn RH as 1s turn LH

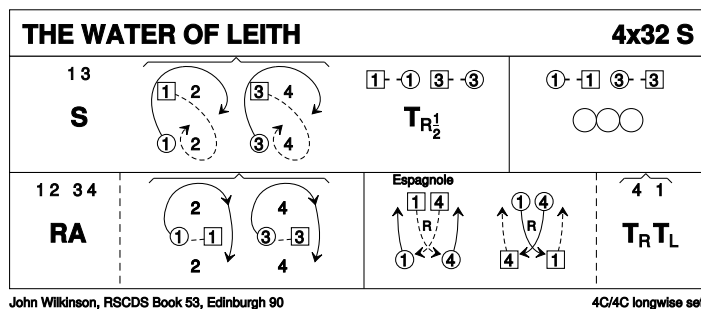

12 MUIRLAND WILLIE J32 · 3/4L

RSCDS XXI 9 · Crib: MiniCribbs · Diagram: Keith Rose's Diagrams

- 1-4 1s lead down middle & cross over to cast up to 2nd pl **while** 2s set & cross RH to 3rd pl **while** 3s cast up to 1st place & cross RH
- 5-8 All set & 1/2 turn 2H to own side
- 9-16 Repeat bars 1- 8 from new pstns
- 17-24 1s lead up to 1st place (4 bars); 1s set (2 bars) then 1s+2s set advancing ready for ...
- 25-32 1s+2s dance Poussette. 2 1 3

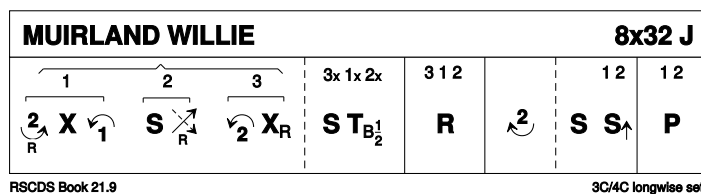

13 SCOTLAND'S GARDENS R32 · 3/4L

Roy Goldring: Auld Friends Meet · Crib: MiniCribbs · Diagram: Keith Rose's Diagrams

- 1-8 1s dance RSh reels of 3 on sides
- 9-16 1s turn 2s RH on sides 1.1/2 times, 1M casts up on own side followed by partner & dances down centre to pick up 3s as 1L picks up 2s
- 17-24 1s with 2s & 3s dance down the middle & back to top with 1L+2s turning to face down
- 25-32 All set, 2s+3s set as 1s petronella turn to opposite sides; all set & 1s cross RH to 2nd place own sides

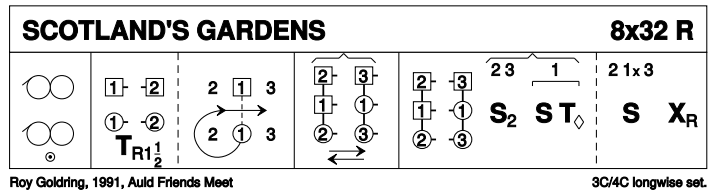

14 CHASING THE ECLIPSE S32 · 3/3L

Sandy Gallamore: The Highland Road Collection · Crib: MiniCribbs · Diagram: Keith Rose's Diagrams

- 1-8 1s set, dance down below 3s (2s step up), cast up to 2nd place, pass LSh to face 1st corners
- 9-16 1s dance RSh reels of 3 on opposite sides, 1s end facing 1st corners
- 17-24 1s set to 1st corners, dance 3/4 round partner by RSh, 1s set to 2nd corners, dance round partner to own side, facing out
- 25-32 Promenade (Chaperoned) Chain progression:
 25-26 2s & 3s 3/4 turn partner RH into middle **while** 1s dance clockwise 1/4 round the set picking up 2L/3M ...
 27-30 who promenade 1/2 way clockwise **while** middle people (2M + 3L) turn LH 1.1/2.
 31-32 2s & 3s turn partner RH 3/4 to own sides **while** 1s dance clockwise 1/4 round to end in 2nd place. 3 1 2

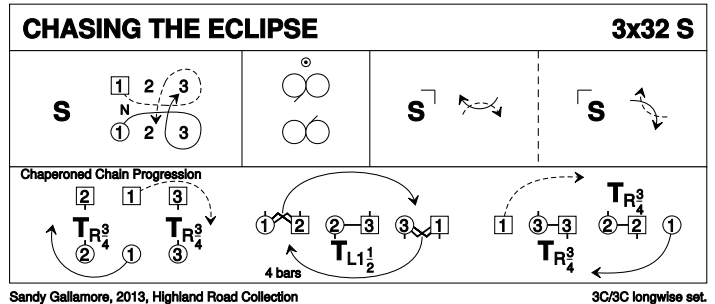

15 OLD NICK'S LUMBER ROOM J32 · 3/4L

RSCDS XXVI 6 · Crib: MiniCribbs · Diagram: Keith Rose's Diagrams

- 1-8 1s turn RH & cast 1 place, lead down between the 3s, cross & cast up to 2nd place on opposite sides
- 9-16 2s+1s+3s set & dance reels of 3 across, 1L with 2s, 1M with 3s
- 17-24 2s+1s+3s dance reels of 3 on sides, 1s cross RH & holding nearer hands face up
- 25-32 2s+1s circle 4H round to left, 1s turn about & 1s+3s circle 4H round to right

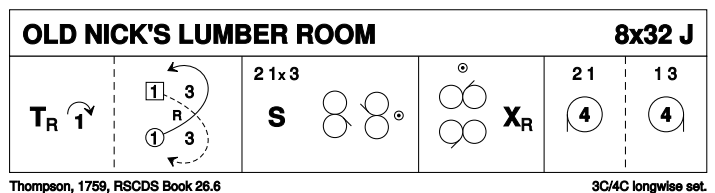

16 SHIFTIN' BOBBINS R32 · 3/4L

Roy Clowes: Thirty Popular Dances, Volume Two · Crib: MiniCribbs · Diagram: Keith Rose's Diagrams

- 1-8 1s cross RH to double triangle position with 2s+3s & set, 1s cast up to top & dance down until they are between 2s & 3s
- 9-16 1L dances RH across with 2M+3M **while** 1M dances LH across with 2L+3L, 1s followed by 2s+3s dance down centre
- 17-24 3s followed by 2s+1s dance up & 3s+2s cast down to places, 1L dances LH across with 2M+3M **while** 1M dances RH across with 2L+3L
- 25-32 1s dance up to top & cast down to 2nd place opposite side, 1s dance 1/2 Fig of 8 around 2s to end in 2nd place on own sides

