

2023-03-14 Atholl SCDC Valma's Programme

1 ANDERSON'S RANT R32 · 3/4L

Miss Milligan's Miscellany of Scottish Country Dances · Crib: MiniCribs · Diagram: Keith Rose's Diagrams

- 1-8 1s cross down to dance reflection (mirror) reels of 3 on opposite sides
- 9-16 1s cross down to dance reflection (mirror) reels of 3 on own sides
- 17-24 1s lead down the middle (2s step up) & lead back up to 2nd place own sides
- 25-32 1s dance 1/2 Fig of 8 round 2s & 1/2 Fig of 8 round 3s back to 2nd place

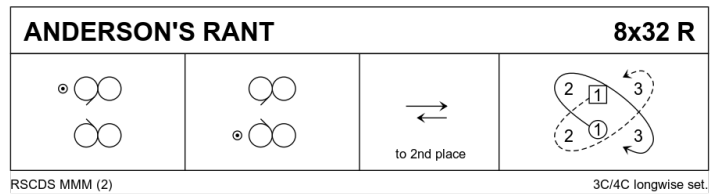

2 THE LANCASTRIAN WANDERER J32 · 3/4L

Ian Barbour: Dance and Celebration · Crib: MiniCribs · Diagram: Keith Rose's Diagrams

- 1-8 1s+2s set, dance RH across & 1s cast to face 1st corners **while** 2s dance up to top place
- 9-16 1s turn 1st corner RH, pass partner RSh to face 3rd corner, turn 3rd corner LH & pass partner LSh to face 2nd corner
- 17-24 1s turn 2nd corner RH, pass partner RSh to face 4th corner, turn 4th corner LH to end in 2nd place opposite side facing 2nd corner
- 25-32 1s dance LSh Reels of 3 on opposite sides & cross to 2nd place on own side. 2 1 3

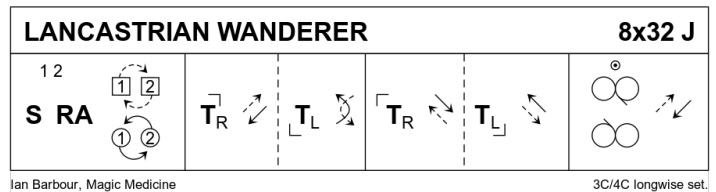

3 THE QUAICH S32 · 3/4L

John Drewry: Bon Accord Book of Scottish Country Dances · Crib: MiniCribs · Diagram: Keith Rose's Diagrams

- 1-8 1s+2s+3s set, petronella turn, set & petronella turn to opposite sides
- 9-16 1s+2s+3s set, cross RH, 1s+2s set facing on sides & turn (Ladies LH & Men RH)
- 17-24 1s dance Inveran Reels with 2s+3s
- 25-32 1s+2s dance the Rondel

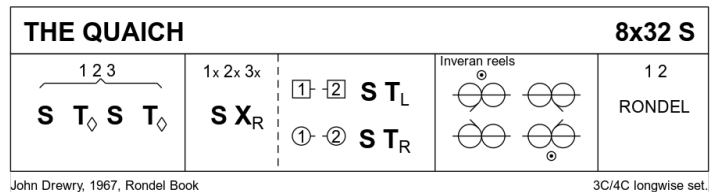

4 PRESTON MILL R32 · 5/5L

Margaret Martin: RSCDS XLV 7 · Crib: MiniCribs · Diagram: Keith Rose's Diagrams

- 1-8 1M crosses down to dance Fig of 8 round 2L+1L **while** 2M crosses down to dance Fig of 8 round 3L+2L **while** 4L crosses up to dance Fig of 8 round 3M+4M **while** 5L crosses up to dance Fig of 8 round 4M+5M all returning to places
- 9-16 1M also 3L followed by partners cast down 1 place & cross to opposite side, 2s+1s also 3s+5s dance LH across
- 17-24 1s & 3s set advancing & turn right about, 1s & 3s dance 6 bars of Double Triangles
- 25-32 1s & 3s dance out own sides & cast 1 place, all set & turn partners RH. 2 4 1 5 3

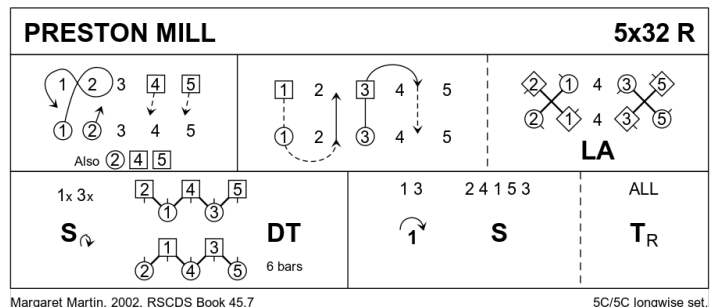

5 MUIRLAND WILLIE J32 · 3/4L

RSCDS XXI 9 · Crib: MiniCribs · Diagram: Keith Rose's Diagrams

- 1-4 1s lead down middle & cross over to cast up to 2nd pl **while** 2s set & cross RH to 3rd pl **while** 3s cast up to 1st place & cross RH
- 5-8 All set & 1/2 turn 2H to own side
- 9-16 Repeat bars 1- 8 from new psstns
- 17-24 1s lead up to 1st place (4 bars); 1s set (2 bars) then 1s+2s set advancing ready for ...
- 25-32 1s+2s dance Poussette. 2 1 3

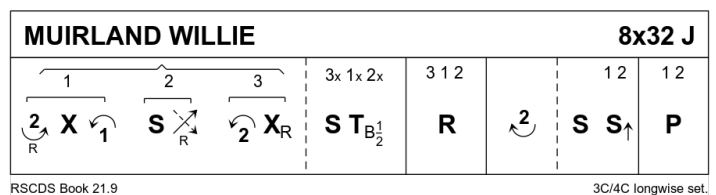

6 SANDS OF MORAR S32 · 3/4L

Barry Priddey: RSCDS XLV 6 · Crib: MiniCribbs · Diagram: Keith Rose's Diagrams

- 1-8** 1s dance Fig of 8 round 2s giving hands when possible
- 9-16** 1s dance reflection reels of 3 on own sides (1s dance down between 2s to begin)
- 17-24** 1s turn 2H & dance down middle to 3rd pl as 2s+3s continue reel & dance down behind 1s, all set & 1s followed by 2s+3s cast up to orig pls
- 25-32** 1s+2s dance the Tourbillon :
1s & 2s turn partners 2H 1/2 way, 1M & 2L lead partners on 1 place clockwise to end 1s on Ladies side & 2s on Men's side, 1s set to 2s
1s & 2s 1/2 turn partners 2H, 1L & 2M lead partners on 1 place to end 2s in 1st pl & 1s in 2nd pl & 2s+1s cross RH to own sides. 2 1 3

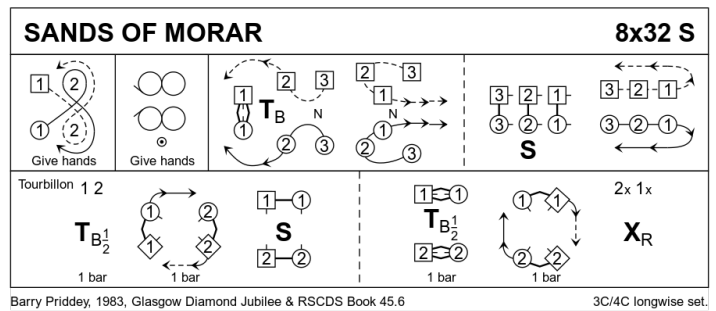

7 BLOOMS OF BON ACCORD R32 · 4/4L

John Drewry: Deeside Book Part 2 · Crib: MiniCribbs · Diagram: Keith Rose's Diagrams

3s & 4s on opp sides

- 1-8** All set & 1s+2s also 3s+4s dance RH across once round, 1s & 4s cast in 1 place to 2 1 (4)(3)
- 9-12** 1s & 4s cross RH & cast to ends of set to meet partners in prom hold & dance into centre of dance
- 13-16** 1s+4s dance round passing RSh & to end 1s in the middle on Men's side facing up & 4s in the middle on Ladies' side facing down
- 17-24** All (1s & 4s in prom hold) dance RSh reels of 3 on sides
- 25-28** 4s+1s dance RH across in centre once round to end 4s facing up & 1s facing down
- 29-32** 4s & 1s lead out of ends crossing & cast in 1 place to end 2 4 (1) (3)

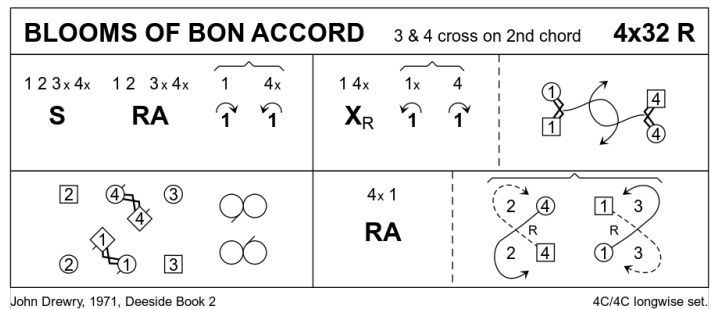

8 FLORA'S FANCY J32 · 3/4L

Members of Tucson Branch and Seven Pipers Scottish Society C.D. class: RSCDS XLIX 8 · Crib: MiniCribbs · Diagram: Keith Rose's Diagrams

- 1-8** 1s set, cast (2s step up). 1L+2s also 1M+3s dance RH across. 1s finish in middle facing up, 1M following 1L
- 9-16** 1s (in tandem) +2s dance reel of 3 across (1s pass 2L RSh). 1s end in 2nd place own sides
- 17-24** 1s set, turn 3/4 RH to face own sides. 1L+2s also 1M+3s dance LH across. 1s finish in middle facing down, 1L following 1M
- 25-32** 1s (in tandem) +3s dance reel of 3 across (1s pass 3M RSh). 1s end in 2nd place own sides

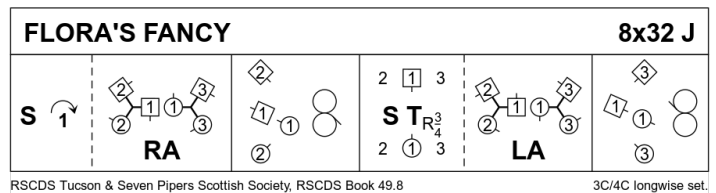

PROGRAMME ITEM – Interval

9 SHE'S A FINE WEE LASS J32 · 3/4L

Jean Grant: RSCDS in East Lothian 1952-2012 14 · Crib: E-cribs

- 1--** 1c+2c set advancing diagonally | retire ; cast clw 1/2 round (2x,1x,3)
- 9--** 1c+3c repeat (2x,3x,1)
- 17--** 1c dance to top, cast to 2pl (3c down) ; All set | 1c turn RH 3/4
- 25--** 2c+1W & 1M+3c LHA ; All set | All cross RH (2,1,3)

10 THE GLENALMOND GAMEKEEPER R40 · 3/4L

John Drewry: Bankhead Book Part 6 · Crib: MiniCribs · Diagram: Keith Rose's Diagrams

- 1-8 1s cross down to dance reflection reels of 3 on opposite sides with 1s & 3s ending in centre facing down/up
- 9-16 1s+3s dance Ladies' Chain ending with 1M facing Ladies' side & 3M facing Men's side with partners behind them
- 17-24 1M also 3M (followed by ptrns & cast to start) dance a Fig of 8 round standing 2s passing firstly LSh in middle & then RSh to end back in middle
- 25-32 1s+2s+3s circle 6H round & back
- 33-40 1s+2s set & dance 3/4 double Fig of 8 (1s cast to start) with 1s ending in 2nd place

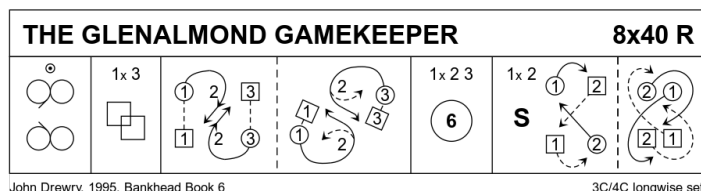

11 THE DREAM CATCHER S96 · 4S

Eileen Orr: RSCDS XLV 9 · Crib: MiniCribs · Diagram: Keith Rose's Diagrams

- 1-8 All circle 8H round & back
- 9-16 1s+3s dance the Swirl:
9-10 Turn partner RH into Allemande hold
11-12 Dance LSh round other couple 1/2 way, on bar 12 drop right hands
13-16 1s+3s dance LH across. On bar 16, pull back LSh & dance on to face side couples (BtoB with ptrn & Lady facing Man, 1L & 3M face 2s, 3L&1M face 4s)
- 17-24 All dance reels of 4 across
- 25-32 All set & dancing couples dance out between side couples, cross & cast to change places RH with partner back into places
- 33-40 All set & advance with partners, retire diagonally with corners & set
- 41-48 1L+4M dance R&L with 3L+2M (on diagonal)
- 49-56 1M+2L dance R&L with 3M+4L (other diagonal)
- 57-64 All set with corners, Adv+Ret with partners & set
- 65-88 2s & 4s repeat bars 9-32
- 89-96 All circle 8H round & back

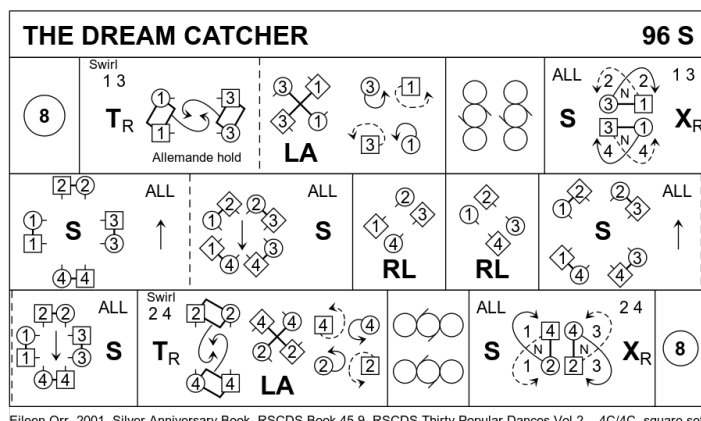

12 LINKS WITH ST PETERSBURG J32 · 3/4L

Malcolm Brown: RSCDS XLVI 10 · Crib: MiniCribs · Diagram: Keith Rose's Diagrams

- 1-8 1s & 2s Set+Link ending 2s facing 1s NHJ, 2s & 1s Set+Link with partners to opposite sides. (2)(1)3
- 9-16 1s followed by 2s dance down for 3 bars & change places with Lady dancing under Mans arm, 2s+1s dance up to 1st & 2nd places
- 17-24 2M+1M turn LH as 2L+1L turn RH, 1M+3M turn RH as 1L+3L turn LH & 1s end facing 1st corners
- 25-32 1s dance 'Hello-Goodbye' setting & petronella turn to 2nd place own sides

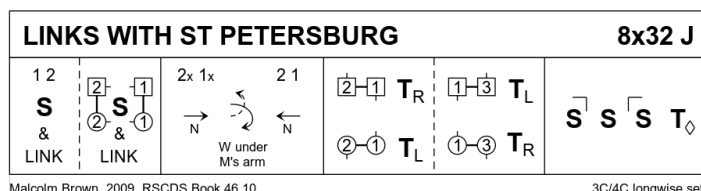

13 FRASER'S FAVOURITE R32 · 3/4L

John Laurie: The Leaflet Dances with Music · Crib: MiniCribs · Diagram: Keith Rose's Diagrams

- 1-8 1M+2L turn RH, 2M+1L turn LH 1.1/2 times to end facing partners
- 9-16 1s+2s dance diagonal RSh reel of 4 (1s end in 2nd place)
- 17-24 1s set advancing to end BtoB Lady facing up Man down & dance Crown Triangles
- 25-32 1s dance RSh reel of 3 on opposite sides giving RSh to 2nd corners & cross back to 2nd place

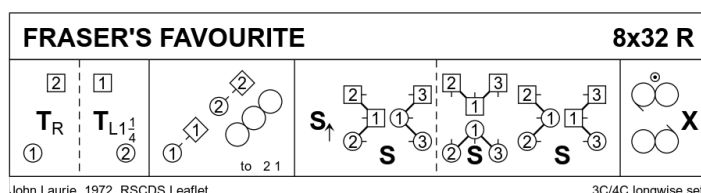

14 THE MINISTER ON THE LOCH S32 · 3/3L

Roy Goldring: Magazine Dances 2005-2009 · Crib: MiniCrib · Diagram: Keith Rose's Diagrams

- 1-8 1s+2s dance Diamond Poussette
- 9-16 1s dance down for 2 steps, turn 2H, dance up to top & turn 2H remaining in centre facing up
- 17-24 1s+3s dance double Fig of 8 round 2s with 1s casting to start
- 25-32 1M+2M turn LH 1.1/2 times **while** 1L+2L turn RH 1.1/2 times, 1M+3M turn RH 1.1/2 times **while** 1L+3L turn LH 1.1/2 times

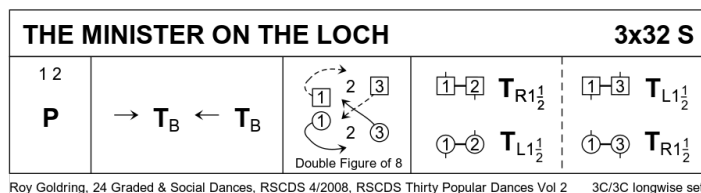

15 HADDINGTON ASSEMBLY J32 · 3/4L

Jean Henderson · Crib: MiniCrib · Diagram: Keith Rose's Diagrams

- 1-8 1s lead down & cast up behind 3s, lead up between 2s & cast down to end facing 2L nearer hands joined
- 9-16 1s set to 2L, turn in to face 3M & set, 1s lead out between 2M & 3M & cast round 3M to face 2M
- 17-24 1s set to 2M, turn in to face 3L & set, 1s lead out between 2L & 3L & cast round 2L
- 25-32 1s dance reels of 3 on opposite sides & cross back to 2nd place

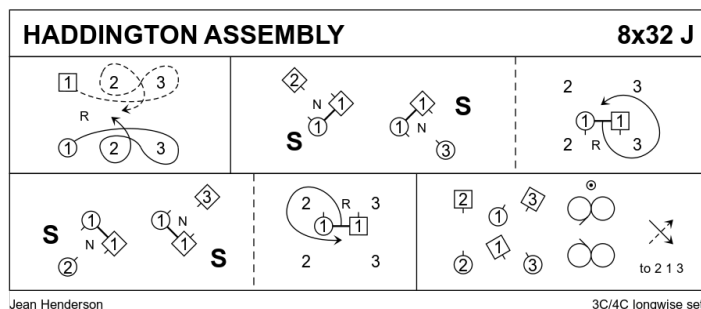

16 THE HIGHLAND RAMBLER R40 · 3/4L

Roy Goldring: Thirty Popular Dances, Volume Two · Crib: MiniCrib · Diagram: Keith Rose's Diagrams

- 1-8 1s dance in & cast to 2nd place, dance RH across with 3s
- 9-16 2s+1s dance LH across, 1L followed by partner cast up round 2L & dance down middle to 1L between 3s & 1M between 2s
- 17-24 1s+2s+3s dance down the middle & back
- 25-32 1M followed by partner dance up, cast down round 2L to 2nd places on own side & turn RH
- 33-40 2s+1s+3s circle 6H round & back

