

# 2022-12-13 Atholl SCDC (Alison A's Programme)

## 1 NEWBURGH JIG J32 · 3/4L

Allana Creighton: RSCDS XLVIII 1 · Crib: MiniCribs · Diagram: Keith Rose's Diagrams

- 1-8 1s+2s+3s dance 6H round and back
- 9-16 1s set, cast off (2s step up), turn LH to face 1st corners
- 17-24 1s+ 1st corners set, 1s dance round each other by right to face 2nd corners. 1s + 2nd corners repeat, 1s finish in middle facing own sides, 1M below 1L
- 25-32 1L+2s also 1M+3s dance LH across. 1s finish in 2nd place opposite sides. 2s+1s+3s set, 1s cross RH to 2nd place own sides

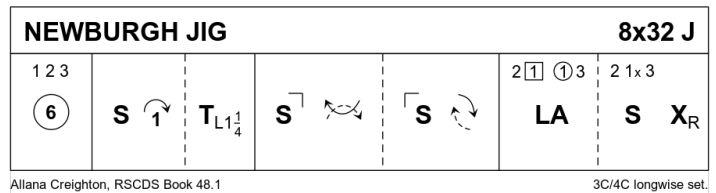

## 2 THE INIMITABLE DEREK R32 · 3/4L

Roy Goldring: Magazine Dances 2005-2009 · Crib: MiniCribs · Diagram: Keith Rose's Diagrams

- 1-8 1s+2s turn 1.1/4 times on sides (Ladies LH, Men RH) to end in line across 1s BtoB, 1s+2s set, Ladies 3/4 turn RH while Men turn 3/4 LH. 2 1 3
- 9-16 1s dance 1/2 reels of 3 on sides (1L in & up, 1M in & down), 2s+3s continue reel while 1s cross to join other reel (1L crosses down to 3rd place Men's side while 1M crosses up to 1st place Ladies side) & 1s turn 3M/2L RH to end in a diagonal line between 2nd corners
- 17-24 1s Bal-in-Line with 2nd corners, 1s turn LH & Bal-in-Line with 1st corners, 1s turn LH to...
- 25-32 1s dance RH across on sides (1L with 2L+3L, 1M with 2M+3M), 1L dances up & casts to 2nd pl own side while 1M dances down & casts up to 2nd pl

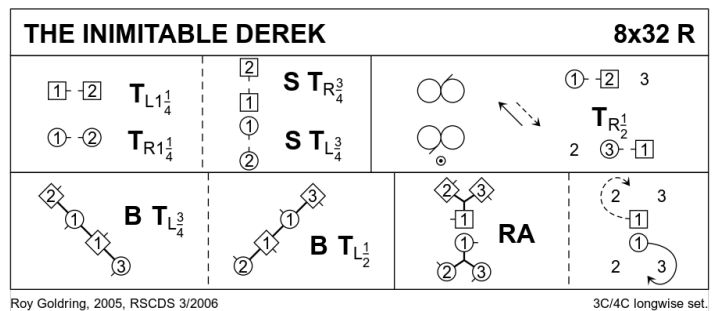

## 3 THE WATER OF LEITH S32 · 4/4L

John Wilkinson: 90 - Twelve anniversary dances celebrating ninety years of RSCDS Edinburgh Branch 11 · Crib: MiniCribs · Diagram: Keith Rose's Diagrams

- 1-8 1s+3s set. 1L dances down, casts up round 2M into middle facing down as 1M dances across, casts round 2L into middle facing up while 3s dance same round 4s. 1s+3s change places RH with partner into line of 4 in middle (M face down, L face up)
- 9-16 1s+3s dance reel of 4 in middle
- 17-20 1s+2s also 3s+4s dance RH across
- 21-24 1M followed by 1L casts round 2L to 2nd place own sides as 3M followed by 3L casts round 4L to 4th place (2s+4s step up 23-24)
- 25-32 1s+4s (middle couples) dance Espagnole
- 25-26 1s+4s cross (Ladies lead across RH passing between Men) with Ladies changing places RH
- 27-28 1s+4s cross back (Men lead across RH between Ladies) with Men changing places RH
- 29-32 4s turn RH as 1s turn LH

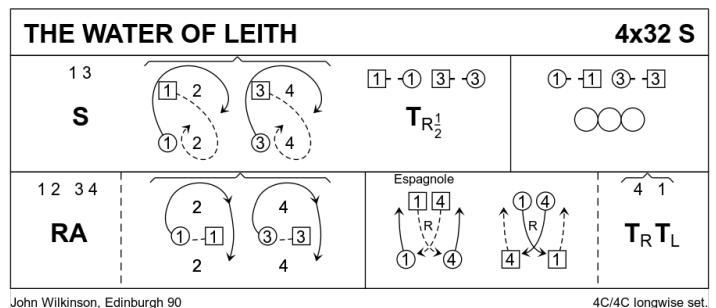

## 4 RODNEY'S RANT J32 · 3/4L

Ann Dix: QE Diamond Jubilee Dances · Crib: MiniCribs · Diagram: Keith Rose's Diagrams

- 1-8 1s set & cast 1 place; 1s dance down between 3s & cast up to 2nd places
- 9-16 1s dance Diag R&L. (3)1(2)
- 17-24 All Set+Link for 3 twice. 2(1)3
- 25-32 1L dances 1/2 Fig of 8 round 2s as 1M dances 1/2 Fig of 8 round 3s (1L up, 1M down); all turn partners RH

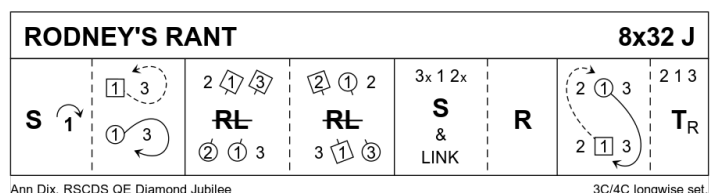

**5 MACFARLANE'S GEESE R32 · 4/4L**

Jean Attwood: *The Gold of Fairmile and Three More SCD · Crib: MiniCribs · Diagram: Keith Rose's Diagrams*

2s & 4s start on opp sides

- 1-8** 1s+3s dance in & Bal-in-Line, turn partners RH & 1s cast to 3rd place **while** 3s lead up to 1st place
- 9-16** 2s+4s dance in & Bal-in-Line, turn partners RH & 2s lead down to 4th place **while** 4s cast up to 2nd place. 3 (4) 1 (2)
- 17-24** 3s+4s also 1s+2s dance double Fig of 8 (1s & 4s cross down/up to start)
- 25-32** 4s+1s set & 1/2 turn partners RH, 4M followed by 1L dance up thru end cple & left round to 3rd/2nd places **while** 1M followed by 4L dance down thru end cple & left round 2nd/3rd places. 3 (1) 4 (2)

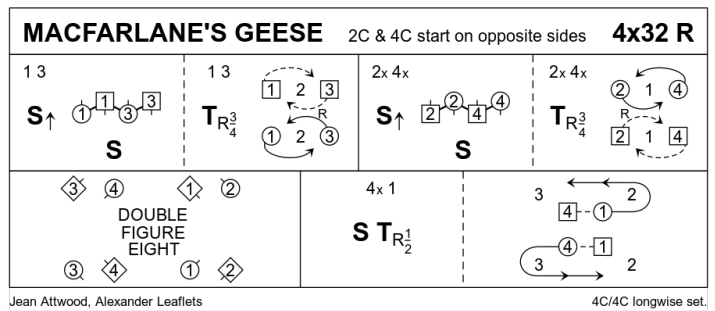

**6 MAY YARKER'S STRATHSPEY S32 · 3/4L**

Roy Goldring: *RSCDS XLII 5 · Crib: MiniCribs · Diagram: Keith Rose's Diagrams*

- 1-8** 1s cross RH, 1s+3s dance 3/4 Fig of 8 round 2s (3s cross up to start). 3 2 1
- 9-16** 2s+1s cross RH, 2s+1s dance RH across 1/2 way, 3s & 1s cross RH & dance RH across 1/2 way. 1 3 2
- 17-24** 1s+3s circle 4H round to left, 1s dance down, cast up round 2s (3rd pl) to 2nd place
- 25-32** 3s+1s+2s dance the Knot

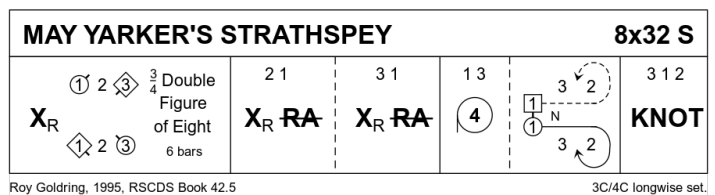

**7 THE GRUMPY GENTLEMAN J32 · 3/4L**

Gillian Jennings: *Birmingham Diamond Jubilee Dance Book - 1946-2006 · Crib: MiniCribs · Diagram: Keith Rose's Diagrams*

- 1-8** 1s+2s Set & Rotate : Set, rotate singly & dance on 1 place clockwise, change places RH on sides & dance on 1 place to own sides (1s in 2nd pl)
- 9-16** 1s dance LSh round 3s & dance 1/2 reel of 3 on sides (RSh to 2s to start) & end facing 1st corners (psth)
- 17-24** 1s dance 1/2 diagonal reel of 4 with 1st corners, pass RSh & dance 1/2 diagonal reel with 2nd corners (psth) to end 2nd place opposite sides. (2) (1) (3)
- 25-32** All set twice & 1/2 turn partner, pull back RSH (twirl) & dance out to places

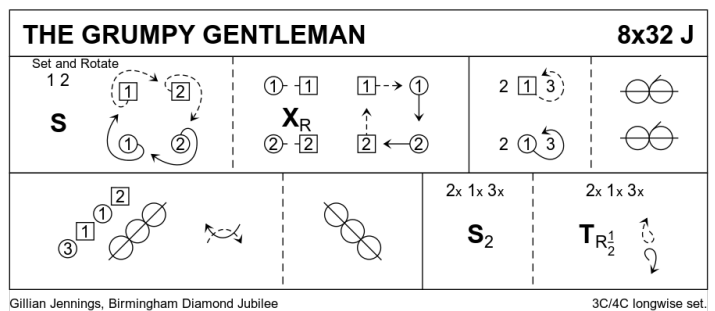

**8 WEST'S HORNPIPE R32 · 4/4L**

Five Traditional Scottish Country Dances for 1965 · Crib: MiniCribs · Diagram: Keith Rose's Diagrams

- 1-8** 1s cross down & dance reflection reels of 3 on opposite sides
- 9-16** 1s cross down to dance reflection reels of 3 on own sides
- 17-24** 1s lead down the middle & back to top (1s end facing 2s diagonally)
- 25-32** 1s set to 2s & dance down to 4th place (2s+3s+4s step up 27-28), 4s+1s circle 4H round to left

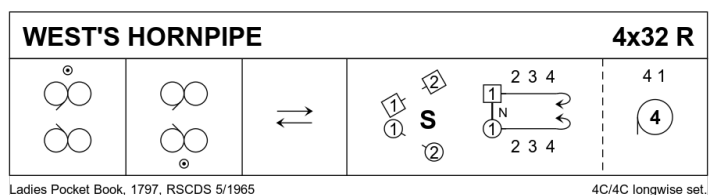

**PROGRAMME ITEM – Interval**

**9 MOLE'S FROLIC J32 · 3/4L**

Tom Winter: *Dunsmuir Dances · Crib: MiniCribs · Diagram: Keith Rose's Diagrams*

- 1-8** 1s set & cast 1 place, dance down between 3s & cast back to 2nd place
- 9-16** 2s+1s+3s set & cross RH, all chase clockwise 1/2 way. 3 1 2
- 17-24** 1s dance RH across (1L with 3s at top, 1M with 2s), LH across with other couple
- 25-32** All chase anticlockwise 1/2 way, all cross LH & set. 2 1 3

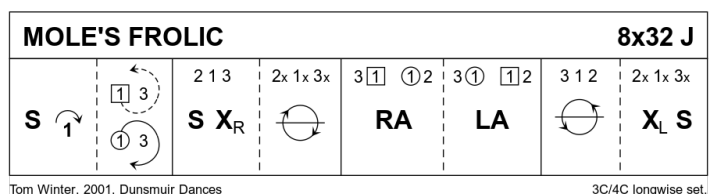

## 10 THE PLANTATION REEL R32 · 5/5L

Tony Moretti: Pinewoods Collection Vol 2 · Crib: MiniCribbs · Diagram: Keith Rose's Diagrams

- 1-8 1s & 3s cross RH & cast down 1 place, lead down between the couple below & cast back to 2nd/4th place (opposite sides)
- 9-16 2s+1s & 4s+3s dance 1/2 R&L & Petronella turn 2 places anticlockwise round square (end in same places as at bar 8)
- 17-24 All dance RH across (1M with 2s, 1L+3M with 4s, 3L with 5s) & 1s & 3s change places with partners to dance LH across
- 25-32 1s & 3s cross RH cast down 1 place & all turn RH

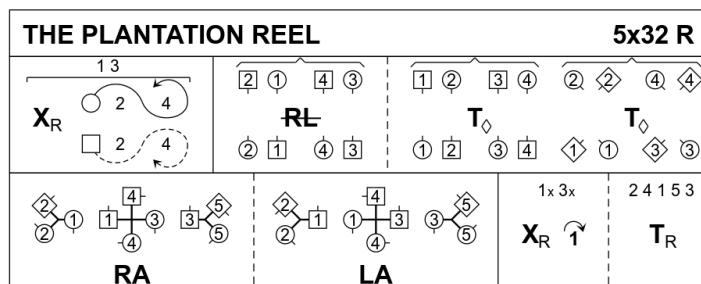

Tony Moretti, Pinewoods 2

5C/5C longwise set.

## 11 PEGGY SPOUSE MBE S32 · 3/4L

John Wilkinson: RSCDS XLVI 11 · Crib: MiniCribbs · Diagram: Keith Rose's Diagrams

- 1-8 1L+2M pass LSh & dance round partners by the RSh to end BtoB facing partners, 1s+2s dance 1/2 Diamond Poussette. 2 1 3
- 9-16 1s dance reels of 3 across giving LSh to 1st corners & end 1L dancing up between 2s to face down as 1M dances down between 3s to face up as 2s dance in to face up to 1L as 3s dance in to face down to 1M
- 17-24 1L+2s also 1M+3s set & circle 3H round to left 1/2 way, 1s set & petronella turn to 2nd place own sides **while** 2s & 3s Set+Link to own sides
- 25-32 2s+1s+3s circle 6H round & back

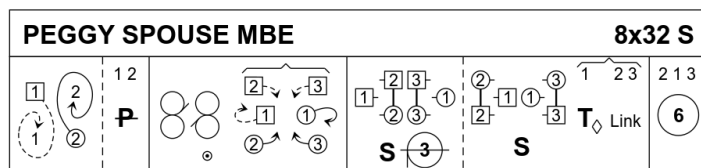

John Wilkinson, RSCDS Book 46.11

3C/4C longwise set.

## 12 NEIL M GRANT J32 · 3/4L

Christine Grant: RSCDS XLIX 1 · Crib: MiniCribbs · Diagram: Keith Rose's Diagrams

- 1-8 1s cross RH, cast (2s step up). 1s dance 1/2 Figs 8 (1M round 2s, 1L round 3s) & join LH giving RH to 1st corners
- 9-16 2s+1s+3s dance The Spoke: 1s Bal-in-Line with 1st corners, then 2nd, 3rd & 4th corners. 1s finish facing 1st corners
- 17-24 1s dance 1/2 diagonal reel of 4 with 1st corners, pass RSh, dance 1/2 diagonal reel of 4 with 2nd corners to finish in 2nd place, opp sides facing clockwise
- 25-32 3s+1s+2s dance clockwise 1/2 way round. 1M+3s & 1L+2s dance RH across

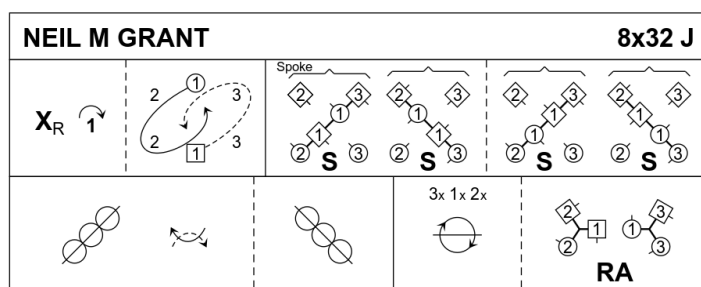

Christine Grant, 2012, RSCDS Book 49.1

3C/4C longwise set.

## 13 SCOTLAND'S GARDENS R32 · 3/4L

Roy Goldring: Auld Friends Meet · Crib: MiniCribbs · Diagram: Keith Rose's Diagrams

- 1-8 1s dance RSh reels of 3 on sides
- 9-16 1s turn 2s RH on sides 1.1/2 times, 1M casts up on own side followed by partner & dances down centre to pick up 3s as 1L picks up 2s
- 17-24 1s with 2s & 3s dance down the middle & back to top with 1L+2s turning to face down
- 25-32 All set, 2s+3s set as 1s petronella turn to opposite sides; all set & 1s cross RH to 2nd place own sides

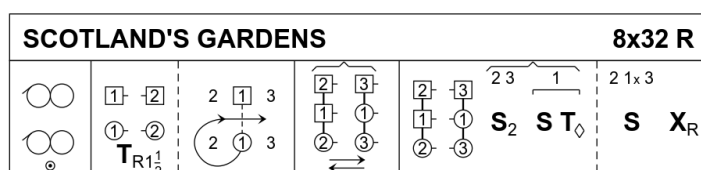

Roy Goldring, 1991, Auld Friends Meet

3C/4C longwise set.

## 14 THE BON VIVEUR M64 · 4S

Ian Brockbank: RSCDS LII 11 · Crib: MiniCribbs · Diagram: Keith Rose's Diagrams

- 1-8 All circle 8H round & back
- 9-16 1s+3s dance Men's Chain finish with Ladies facing out
- 17-28 All dance Schiehallion reels (12 bars) to finish 1 place clockwise from starting place 4 1 2 3
- 29-32 All birl (or turn) partners RH End 4 1 2 3

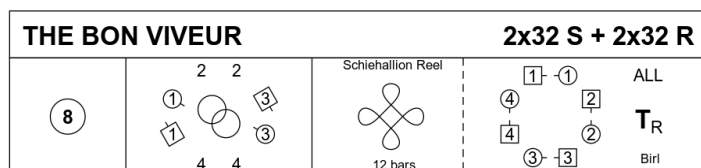

Ian Brockbank, 2015, RSCDS Book 52.11

4C/4C square set.

Note: Dance twice as Strathspey, twice as Reel

## 15 THE KELLOHOLM JIG J32 · 3/4L

Peter Hyssett: *The Leaflet Dances with Music* · Crib: *MiniCribbs* · Diagram: *Keith Rose's Diagrams*

- 1-8 1s set & cast 1 place, set on side lines to 1st corners & change places with them RH
- 9-16 1L+3L also 2M+1M set to each other on sides & change places LH, 1s turn RH 1.1/2 times to 2nd place on own sides
- 17-24 1s set on side lines to 2nd corners & change places with them RH, 1M+3M also 2L+1L set to each other on sides & change places LH
- 25-32 3s+1s+2s Adv+Ret, circle 6H round 1/2 way to left

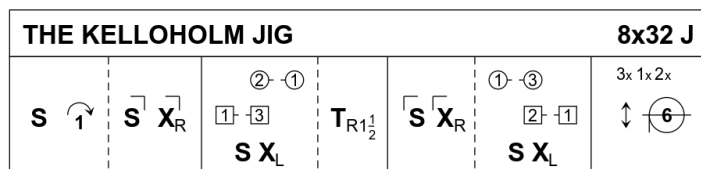

Peter Hyssett, RSCDS Leaflet 32

3C/4C longwise set.

## 16 THE MONTGOMERIES' RANT R32 · 3/4L

Castle Menzies (18C): *RSCDS X 1* · Crib: *MiniCribbs* · Diagram: *Keith Rose's Diagrams*

- 1-8 1s cross RH & cast down to 2nd place (2s step up), cross LH & 1L casts up **while** 1M casts down
- 9-16 1s dance reels of 3 across, 1L with 2s (RSh to 2M) & 1M with 3s (RSh to 3L)
- 17-24 1s NHJ (Lady on Mans left) set to 2L & turn inwards to set to 3M, set to 3L & turn inward & set to 2M. End facing own 2nd corner (1L pull back LSh to face down)
- 25-32 2s+1s+3s dance reels of 3 on opposite sides 1s giving RSh to 2nd corner, 1s cross RH to 2nd place own sides

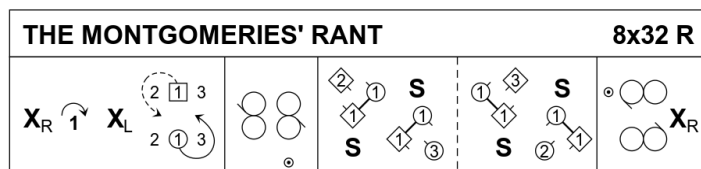

Castle Menzies, 1749, RSCDS Book 10.1

3C/4C longwise set.